

job name:
 type:

9" tiki.aura™ spec sheet 90CRI

material

downlight housing

precision CNC spun .063" aluminum. downlight housing with rolled bottom edge for added strength.

uplight housing

.125 translucent white acrylic inverted bell.

downlight array platform

.080" spun aluminum.

bottom lens (optional)

.125" P95 frosted acrylic flat lens with 3 finger holes. recesses slightly into fixture.

optics

uplight (optional)

340° omnidirectional silicone optic

downlight

.050" spun aluminum conical reflector finished in high reflectance (>92%) matte white powder coat.

LED module

COB array in 2700K, 3000K, 3500K, or 4000K. (call factory for 5000K) (90+ cri standard). under normal operating conditions, the LEDs employed are rated for >50,000hrs L70 (6.8K) per IES TM-21 from LM-80 test data.

driver

integral, class 2, universal input (120-277v), constant current, 0-10v dimming, 1% minimum dimming level, PF >.9, THD <20%, protections include open and short circuit, overload and over temperature.

mounting

5"dia. spun steel canopy in satin white with 6ft ultrathin stainless steel wisp cable tripod and tiny field adjustable grippers that allow for exact AFF mounting heights. or select 12ft adjustable suspension. (drawing below)

finish

select from standard powder coat paint finishes or specify RAL# for custom colors.

emergency

recommend use of inverter (by other).

optional WREM: wired for remote EM battery (by other). 2nd power cord required.



catalog number

P4109						
size	direct LED		indirect LED		power cord	
P4109 9"dia X 11.25"ht see pages 2 & 3 for info on P4113 and P4117	CCT lumens		CCT lumens		options	
	27 2700K LO 995 lm		27 2700K UP 970 lm		6FT 72" cables	
	30 3000K HI 1985 lm		30 3000K NUL no uplight		12FT 12ft adj suspension	
	35 3500K HX 2780 lm		35 3500K		BL Bottom lens	
	40 4000K		40 4000K		DCDM dual circuit wiring on dimming direct/indirect (requires 2nd power cord)	
					WREM wired for remote EM battery pack (by other) (see note above)	
					ELD EldoLED*	
					LUT Lutron* *consult factory	
				premium finish RAL specify RAL#		
				painted finish		
				AP anodized paint		
				BS brass		
				BU blue		
				BZ bronze		
				CP champagne		
				FB flat black		
				GM gun metal		
				MB military blue		
				MW matte white		
				OR orange		
				RD red		
				SB satin black		
				SS satin silver		
				TG textured gray		
				YO yellow		

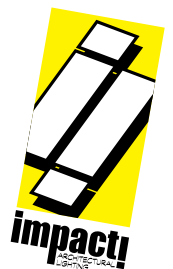
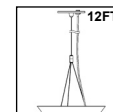

job name:
 type:

13" tiki.aura™ spec sheet 90CRI

material

downlight housing

precision CNC spun .063" aluminum. downlight housing with rolled bottom edge for added strength.

uplight housing

.125 translucent white acrylic inverted bell.

downlight array platform

.080" spun aluminum.

bottom lens (optional)

.125" P95 frosted acrylic flat lens with 3 finger holes. recesses slightly into fixture.

optics

uplight (optional)

340° omnidirectional silicone optic

downlight

.050" spun aluminum conical reflector finished in high reflectance (>92%) matte white powder coat.

LED module

COB array in 2700K, 3000K, 3500K, or 4000K. (call factory for 5000K) (90+ cri standard). under normal operating conditions, the LEDs employed are rated for >50,000hrs L70 (6.8K) per IES TM-21 from LM-80 test data. for dual circuit wiring on direct/indirect dimming luminaires, specify under options.

driver

integral, programmable, UL class P, class 2, universal input (120-277v), constant current, 0-10v dimming, 1% minimum dimming level, PF >.9, THD <20%, protections include open and short circuit, overload and over temperature.

mounting

5"dia. spun steel canopy in satin white with 6ft ultrathin stainless steel wisp cable tripod and tiny field adjustable grippers that allow for exact AFF mounting heights. or select 12ft adjustable suspension. (drawing below)

finish

select from standard powder coat paint finishes listed below or specify RAL# for custom colors.

emergency

recommend use of inverter (by other).

optional WREM: wired for remote EM battery (by other). 2nd power cord required.



catalog number

P4113						
size	direct LED	indirect LED	painted finish	power cord	options	
P4113 13"dia X 16"ht see page 3 for info on P4117	CCT lumens 27 2700K FX 1585 lm 30 3000K LO 2975 lm 35 3500K HI 3375 lm 40 4000K HX 4120 lm CL* xxxx lm custom lumens consult factory	CCT lumens 27 2700K FX 775 lm 30 3000K LO 1745 lm 35 3500K HI 1940 lm 40 4000K NUL no uplight CL* xxxx lm custom lumens consult factory	AP anodized paint BS brass BU blue BZ bronze CP champagne FB flat black GM gun metal MB military blue MW matte white OR orange RD red SB satin black SS satin silver TG textured gray YO yellow premium finish RAL specify RAL#	WHPC white power cord and canopy BKPC black power cord and canopy SBPC silver braid power cord and white canopy	6FT 72" cables 12FT 12ft adj suspension BL Bottom lens DCDM dual circuit wiring on dimming direct/indirect (requires 2nd power cord) WREM wired for remote EM battery pack (by other) (see note above) ELD EldoLED* LUT Lutron* *consult factory	

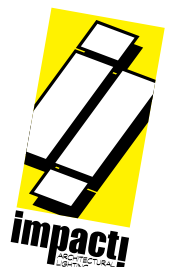
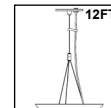

job name:
 type:

17" tiki.aura™ spec sheet 90CRI

material

downlight housing

precision CNC spun .063" aluminum. downlight housing with rolled bottom edge for added strength.

uplight housing

.125 translucent white acrylic inverted bell.

downlight array platform

.080" spun aluminum.

bottom lens (optional)

.125" P95 frosted acrylic flat lens with 3 finger holes. recesses slightly into fixture.

optics

uplight (optional)

340° omnidirectional silicone optic

downlight

.050" spun aluminum conical reflector finished in high reflectance (>92%) matte white powder coat.

LED module

COB array in 2700K, 3000K, 3500K, or 4000K. (call factory for 5000K) (90+ cri standard). under normal operating conditions, the LEDs employed are rated for >50,000hrs L70 (6.8K) per IES TM-21 from LM-80 test data. for dual circuit wiring on direct/indirect dimming luminaires, specify under options.

driver

integral, programmable, UL class P, class 2, universal input (120-277v), constant current, 0-10v dimming, 1% minimum dimming level, PF >.9, THD <20%, protections include open and short circuit, overload and over temperature.

mounting

5"dia. spun steel canopy in satin white with 6ft ultrathin stainless steel wisp cable tripod and tiny field adjustable grippers that allow for exact AFF mounting heights. or select 12ft adjustable suspension. (drawing below)

finish

select from standard powder coat paint finishes listed below or specify RAL# for custom colors.

emergency

recommend use of inverter (by other).

optional WREM: wired for remote EM battery (by other). 2nd power cord required.



catalog number

P4117						
size	direct LED	indirect LED	painted finish	power cord	options	
P4117 17"dia X 21"ht	CCT lumens	CCT lumens	AP anodized paint	WHPC white power cord and canopy	6FT 72" cables	
	27 2700K FX 2580 lm	27 2700K FX 775 lm	BS brass	BKPC black power cord and canopy	12FT 12ft adj suspension	
	30 3000K LO 3375 lm	30 3000K LO 1550 lm	BU blue	SBPC silver braid power cord and white canopy	BL Bottom lens	
	35 3500K HI 4550 lm	35 3500K HI 2135 lm	BZ bronze		DCDM dual circuit wiring on dimming direct/indirect (requires 2nd power cord)	
	40 4000K HX 4985 lm	40 4000K NUL no uplight	CP champagne		WREM wired for remote EM battery pack (by other) (see note above)	
	CL* xxxx lm custom lumens consult factory	CL* xxxx lm custom lumens consult factory	FB flat black		ELD EldoLED*	
			GM gun metal		LUT Lutron*	*consult factory
			MB military blue			
			MW matte white			
			OR orange			
			RD red			
			SB satin black			
			SS satin silver			
			TG textured gray			
			YO yellow			
			premium finish			
			RAL specify RAL#			

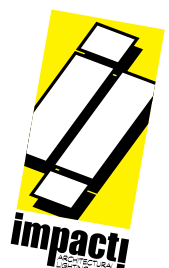
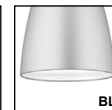
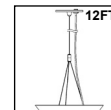

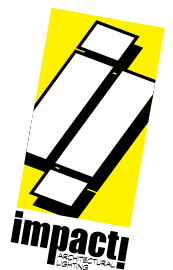
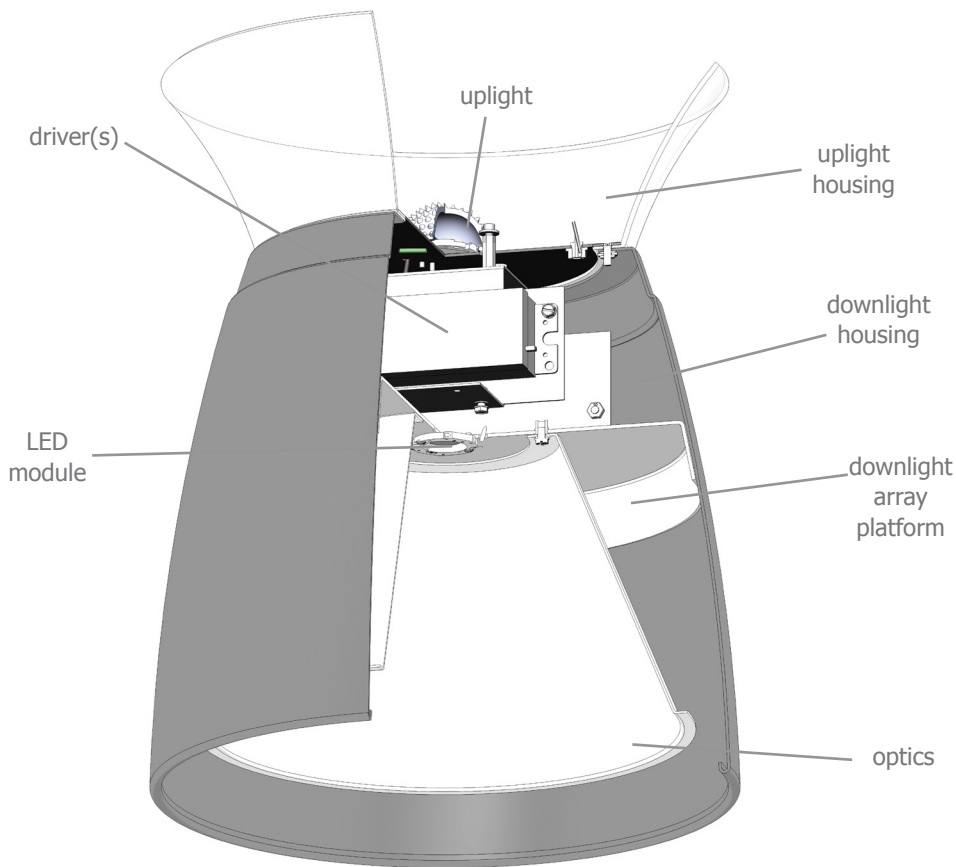
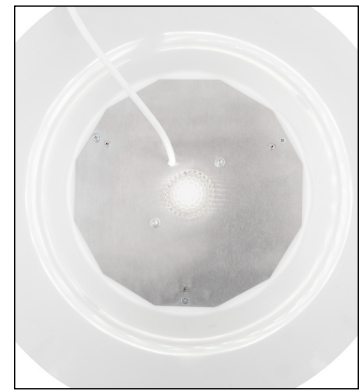
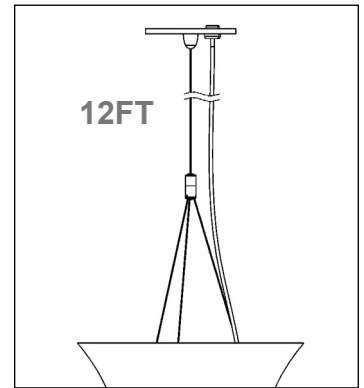
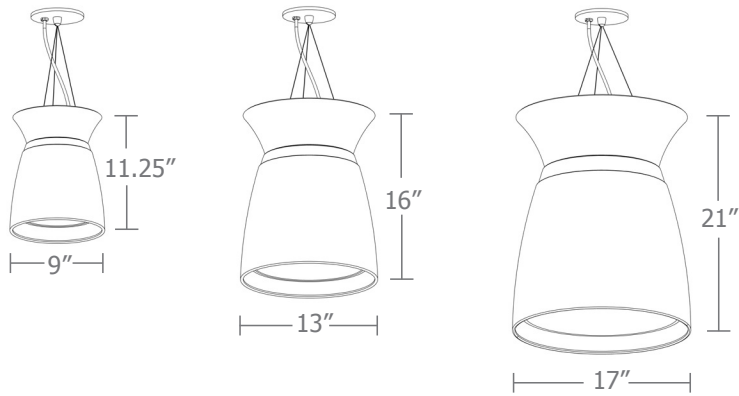

Quick Calc Typical Lighting Layout

- 10' x 10' x 16'H space
- 80/50/20 reflectances
- bottom of fixture at 12' aff
- FC readings at 2.5' aff
- layout conducted using 17" dia. unit with HI lumen 90 CRI package providing 6685 delivered lumens

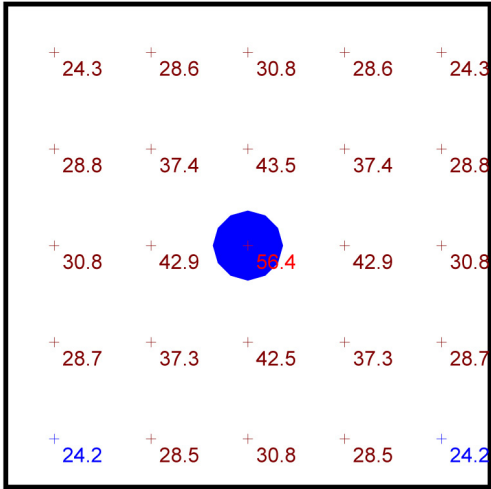

Plan View
Scale - 1" = 2ft

Statistics

Description	Symbol	Avg	Max	Min	Max/Min	Avg/Min
tiki.aura	+	33.1 fc	56.4 fc	24.2 fc	2.3:1	1.4:1

Schedule

Symbol	QTY	Manufacturer	Catalog Number	Description	Lamp	Wattage
○	1	Impact Architectural Lighting LLC	P4117 40 HI 40 HI	17" dia. pendant tiki.aura luminaire w/ open bottom	4000k 90cri LED	68

Advanced Calculation Typical Lighting Layout

- 10' x 10' x 16'H space
- 80/50/20 reflectances
- bottom of fixture at 12' aff
- FC readings at 2.5' aff
- layout conducted using 17" dia. unit with HX output 90 CRI 4985 lumen downlight package and HI output 2135 lumen uplight package for total of 7120 delivered lumens

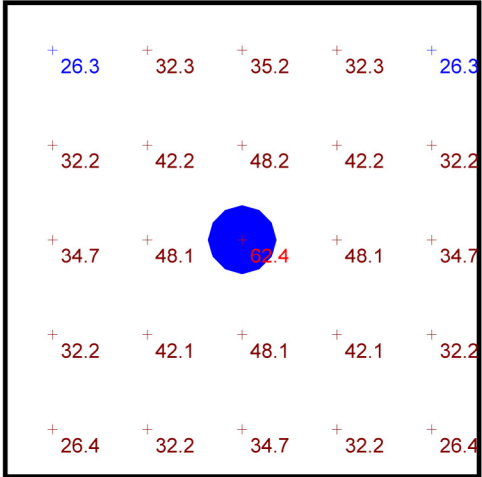

Plan View
Scale - 1" = 2ft

Statistics

Description	Symbol	Avg	Max	Min	Max/Min	Avg/Min
tiki.aura	+	37.0 fc	62.4 fc	26.3 fc	2.4:1	1.4:1

Schedule

Symbol	QTY	Manufacturer	Catalog Number	Description	Lamp	Wattage
○	1	Impact Architectural Lighting	P4117 40HX NUL	17" dia.pendant tiki.aura open downlight only component	4000k 90cri LED	51
○	1	Impact Architectural Lighting LLC	P4117 NDL 40HI	17" dia. pendant tiki.aura uplight only component	4000k 90cri LED	22

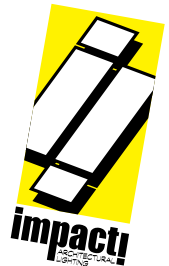

Quick Calc Table

Tests indicated below are a combination of direct and indirect. LLF are as close as possible.

for more detailed calculations see table on next page.

Cat No	Direct Delivered* Lumens	Indirect Delivered* Lumens	Watts 120V / 277V	IES File #	LLF to be applied
P4109 LO UP	995	970	20	10211A09A open	.52
				20154 lensed	.55
P4109 HI UP	1985	970	30	10211A09A open	.78
				20154 lensed	.82
P4109 HX UP	2780	970	39	10211A09A open	.99
				20154 lensed	1.03
P4113 FX FX	1585	775	24	10212A13A open	.38
				20620.1 lensed	.39
P4113 LO LO	2975	1745	49	10212A13A open	.75
				20620.1 lensed	.73
P4113 HI HI	3375	1940	55	10212A13A open	.85
				20620.1 lensed	.87
P4113 HX HI	4120	1940	62	10212A13A open	.97
				20620.1 lensed	.99
P4117 FX FX	2580	775	35	10213A17A open	.43
				20620.1 lensed	.55
P4117 LO LO	3375	1550	51	10213A17A open	.64
				20620.1 lensed	.81
P4117 HI HI	4550	2135	68	10213A17A open	.86
				20620.1 lensed	1.09
P4117 HX HI	4985	2135	73	10213A17A open	.92
				20620.1 lensed	1.17

*delivered lumens based on 4000K, 90+ cri

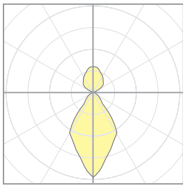

20689
P5117-40CL (4000lm) 40HI

The application of a Light Loss Factor is required to:

- match the lumen output for the power module specified
- incorporate the increased lumen output due to LED/Driver upgrades

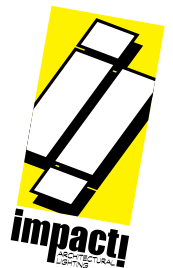

Advanced Calculation Table

Tests are for each element separately and must be "stacked" to represent single fixture
Consult factory for applications assistance

Direct

Cat No	Delivered* Lumens	Watts 120V/277V	IES File #	LLF to be applied
P5409	LO 995	10	10211A09C open	.40
			20617.1 lensed	.24
P5409	HI 1985	21	10211A09C open	.79
			20617.1 lensed	.48
P5409	HX 2780	29	10211A09C open	1.11
			20617.1 lensed	.67
P5413	FX 1585	16	20616.1 open	.41
			20617.1 lensed	.38
P5413	LO 2975	31	20616.1 open	.78
			20617.1 lensed	.72
P5413	HI 3375	35	20616.1 open	.88
			20617.1 lensed	.82
P5413	HX 4120	42	20616.1 open	1.07
			20617.1 lensed	1.00
P5417	FX 2580	27	20688 open	.62
			20617.1 lensed	.62
P5417	LO 3375	35	20688 open	.81
			20617.1 lensed	.82
P5417	HI 4550	47	20688 open	1.09
			20617.1 lensed	1.10
P5417	HX 4985	51	20688 open	1.19
			20617.1 lensed	1.21

Indirect

Delivered* Lumens	Watts 120V/277V	IES File #	LLF to be applied
UP 970	10	10211A09B	.79
FX 775	8	10212A13B	.37
LO 1745	18	10212A13B	.83
HI 1940	20	10212A13B	.93
FX 775	8	10213A17B	.31
LO 1550	16	10213A17B	.62
HI 2135	22	10213A17B	.86

*delivered lumens based on 4000K, 90+ cri

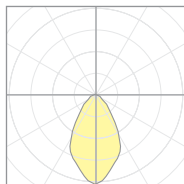

20617.1
P4913-40CL (3700lm)

The application of a Light Loss Factor is required to:

- match the lumen output for the power module specified
- incorporate the increased lumen output due to LED/Driver upgrades

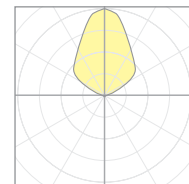

10212A13B
P4113

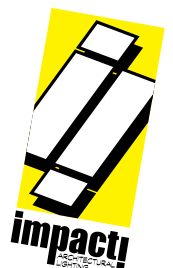

Powder Coat Paint Finishes

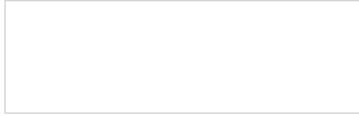

MW matte white

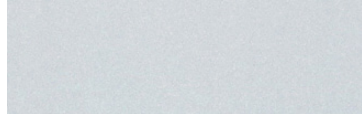

AP anodized paint

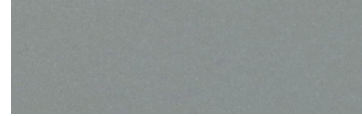

SS satin silver



TG textured gray

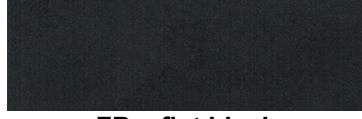

FB flat black



SB satin black



CP champagne

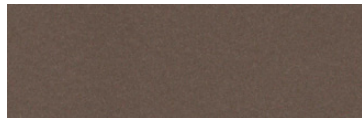

BZ bronze

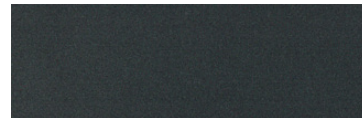

GM gun metal



OR orange 2011



BU blue 5017



BS brass



RD red 3020



YO yellow 1018



MB military blue

For accurate color verification, actual finish samples are available upon request.

Premium Finishes*



RAL#

*Available on select series. Consult product submittal for availability.

